



Vegetable Slicer TR210 Vegetable Slicer Motor block only - 2 Speeds

ITEM # _____

MODEL # _____

NAME # _____

SIS # _____

AIA # _____



602231 (TR210)

Motor block for vegetable slicer, 2 speeds 340-680 rpm (hopper not included)

Short Form Specification

Item No. _____

For catering facilities, up to 1000 meals per service, specially designed for cuts of vegetables. 2 speeds vegetable slicer (340 and 680 rpm). "No volt release" safety device. Self-braking motor. On/off switch on the body of the machine. Table top version. Motor block only, hopper not included. Add standard lever operated hopper and/or long vegetable hopper and discs/grids to operate the appliance.

APPROVAL: _____

Main Features

- High flexibility and ergonomcy thanks to the available optional accessories.
- Smart design trolley to place the unit and the 2/1 GN tray to collect cut veggies, to maximize productivity and grant effortless operation (optional).
- Suitable for 100-800 meals for table service and up to 1000 meals for catering service.
- Vegetable slicer with slicing, grating, shredding (julienne) as well as dicing and French fries cutting capability.
- Complete and wide selection of blades and grids available (diam. 205 mm).
- Lever operated hopper (including long vegetable and half moon hoppers) to reach the maximum precision in the result (optional).
- [NOT TRANSLATED]
- [NOT TRANSLATED]

Construction

- Power: 750 watts.
- 2 speeds: 340-680 rpm.
- Asynchronous silent industrial motor for heavy duty and longer life.
- Discs (available on request) are made in stainless steel and dishwasher safe.

Optional Accessories

- SS TROLLEY FOR TR 210 AND 2/1GN TRAY PNC 650065
- Stainless steel shredding disc with S-blades 4x4 mm PNC 650077
- Stainless steel shredding disc with S-blades 6x6 mm (can also be used for chips) PNC 650078
- Stainless steel shredding disc with S-blades 8x8 mm (can also be used for chips) PNC 650079
- Stainless steel shredding disc with S-blades 10x10 mm (can also be used for chips) PNC 650080
- Stainless steel slicing disc with S-blades 0,6 mm PNC 650081
- Stainless steel slicing disc with S-blades 1 mm PNC 650082
- Stainless steel slicing disc with S-blades 2 mm PNC 650083
- Stainless steel slicing disc with S-blades 3 mm PNC 650084
- Stainless steel slicing disc with S-blades 4 mm PNC 650085
- Stainless steel slicing disc with S-blades 5 mm PNC 650086
- Stainless steel slicing disc with S-blades 6 mm PNC 650087
- Stainless steel slicing disc with S-blades 8 mm PNC 650088

TR210 Vegetable Slicer Motor block only - 2 Speeds
Vegetable Slicer



Vegetable Slicer TR210 Vegetable Slicer Motor block only - 2 Speeds

• Stainless steel disc with corrugated S-blades 2 mm	PNC 650089	<input type="checkbox"/>	• Dicing grid 20x20 mm	PNC 653570	<input type="checkbox"/>
• Stainless steel disc with corrugated S-blades 3 mm	PNC 650090	<input type="checkbox"/>	• Grid for chips 6x6 mm	PNC 653571	<input type="checkbox"/>
• Stainless steel disc with corrugated S-blades 6 mm	PNC 650091	<input type="checkbox"/>	• Grid for chips 8x8 mm	PNC 653572	<input type="checkbox"/>
• Bistrot Pack-set stainless steel discs (C2S-2mm slicing disc, C5S-5mm slicing disc, J2X-2mm grating disc)	PNC 650092	<input type="checkbox"/>	• Grid for chips 10x10 mm	PNC 653573	<input type="checkbox"/>
• SS LEVER-OPER.HOPPER TR210 (NO CUTT.CHAMBER,NO EJECT.) WXXDXH 250X510X260MM 6KG 0.1M ³	PNC 650094	<input type="checkbox"/>	• SUPPORT FOR 1 DISC-DIAM 175MM AND 205MM	PNC 653632	<input type="checkbox"/>
• DISC SET PIZZA (C2SX, C4SX, J7X)	PNC 650107	<input type="checkbox"/>	• Ejector disc	PNC 653772	<input type="checkbox"/>
• SS LONG VEGETABLE HOPPER WITH 4 TUBES+PUSHER AND SAFETY DEVICE FOR TR210	PNC 650109	<input type="checkbox"/>	• Stainless steel grating disc 2 mm	PNC 653773	<input type="checkbox"/>
• CLEANING TOOL FOR TRS-TRK-TRK210 5/8/10MM DICING GRIDS	PNC 650110	<input type="checkbox"/>	• Stainless steel grating disc 3 mm	PNC 653774	<input type="checkbox"/>
• DICING KIT 10X10X10MM: SLICER, GRID	PNC 650112	<input type="checkbox"/>	• Stainless steel grating disc 4 mm	PNC 653775	<input type="checkbox"/>
• - NOT TRANSLATED -	PNC 650113	<input type="checkbox"/>	• Stainless steel grating disc 7 mm	PNC 653776	<input type="checkbox"/>
• - NOT TRANSLATED -	PNC 650114	<input type="checkbox"/>	• Stainless steel grating disc 9 mm	PNC 653777	<input type="checkbox"/>
• PRESSER SLICING DISC STRAIGHT BLADE 10MM	PNC 650115	<input type="checkbox"/>	• Stainless steel grating disc for knoedeln and bread	PNC 653778	<input type="checkbox"/>
• PRESSER SLICING DISC STRAIGHT BLADE 8MM	PNC 650116	<input type="checkbox"/>	• Stainless steel grating disc for parmesan and bread	PNC 653779	<input type="checkbox"/>
• Stainless steel shredding disc with S-blades 2x8 mm	PNC 650158	<input type="checkbox"/>			
• Stainless steel shredding disc with S-blades 2x10 mm	PNC 650159	<input type="checkbox"/>			
• Stainless steel pressing/slicing disc with S-blades (balanced) 10 mm (can be used for slicing or combined with grids)	PNC 650160	<input type="checkbox"/>			
• Stainless steel pressing/slicing disc with S-blades (balanced) 12 mm (can be used for slicing or combined with grids)	PNC 650161	<input type="checkbox"/>			
• Stainless steel pressing/slicing disc with corrugated S-blades (balanced) 8 mm (can be used for slicing or combined with grids)	PNC 650162	<input type="checkbox"/>			
• Stainless steel pressing/slicing disc with corrugated S-blades (balanced) 10 mm (can be used for slicing or combined with grids)	PNC 650164	<input type="checkbox"/>			
• Stainless steel pressing/slicing disc with S-blades (balanced) 13 mm (can be used for slicing or combined with grids)	PNC 650165	<input type="checkbox"/>			
• Stainless steel shredding disc with S-blades 2x2 mm	PNC 650166	<input type="checkbox"/>			
• Stainless steel shredding disc with S-blades 3x3 mm	PNC 650167	<input type="checkbox"/>			
• Set of 4 stainless steel discs (C2S-2mm and C5S-5mm slicing disc, J2X-2mm and J7X-7mm grating disc)	PNC 650178	<input type="checkbox"/>			
• Dicing grid 5x5 mm	PNC 653566	<input type="checkbox"/>			
• Dicing grid 8x8 mm	PNC 653567	<input type="checkbox"/>			
• Dicing grid 10x10 mm	PNC 653568	<input type="checkbox"/>			
• Dicing grid 12x12 mm	PNC 653569	<input type="checkbox"/>			



Vegetable Slicer
TR210 Vegetable Slicer Motor block only - 2 Speeds
The company reserves the right to make modifications to the products without prior notice. All information correct at time of printing.

2026.05.21



Vegetable Slicer TR210 Vegetable Slicer Motor block only - 2 Speeds

Front

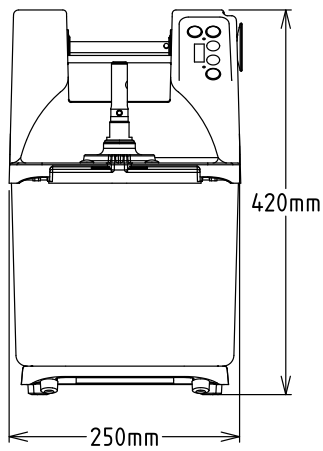

Electric

Supply voltage:	380-415/380-440 V/3 ph/50/60 Hz
Electrical power max.:	0.75 kW
Total Watts:	0.75 kW

Capacity:

Performance (up to):	2100 kg/Cycle
-----------------------------	---------------

Key Information:

External dimensions, Width:	400 mm
External dimensions, Depth:	250 mm
External dimensions, Height:	420 mm
Shipping weight:	34.7 kg

Side

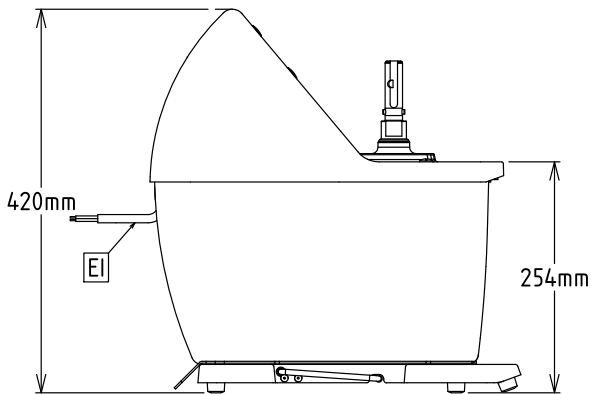

EI = Electrical inlet
(power)

Top

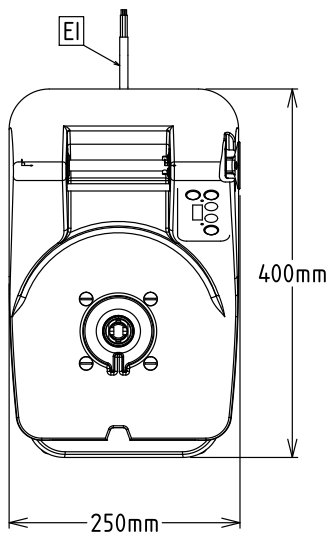

Vegetable Slicer
TR210 Vegetable Slicer Motor block only - 2 Speeds
The company reserves the right to make modifications to the products
without prior notice. All information correct at time of printing.

2026.05.21